

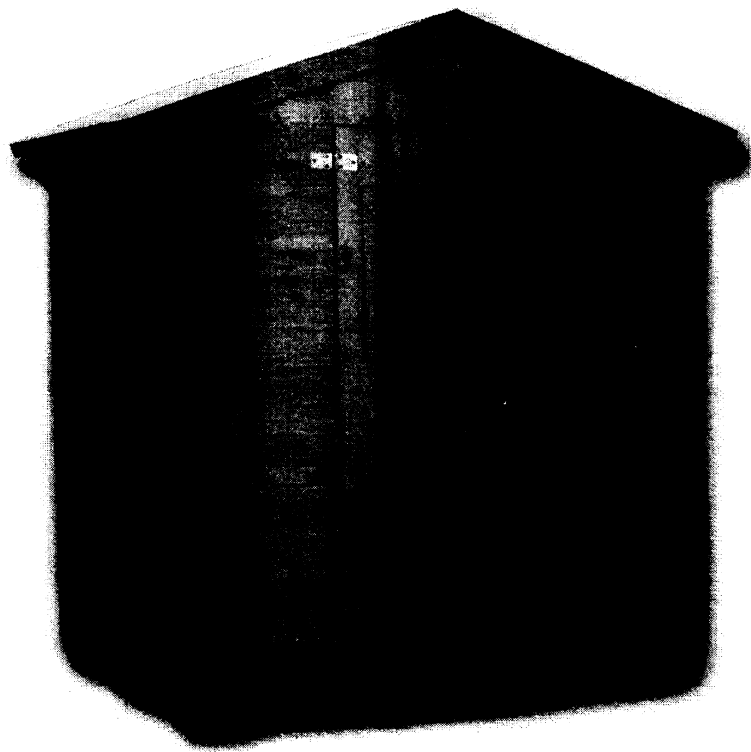

















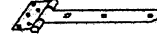
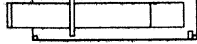

# MONTAGEANLEITUNG

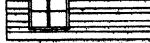
Gerätehaus

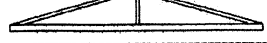
Berlin-1

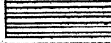
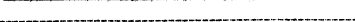

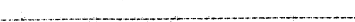
**Stückliste Berlin-1 (D-175)**

Pos	NAME	Dimension	Anzahl	Element
1	Holzschrauben	4x50	48	
2	Holzschrauben	5x80	14	
3	Holzschrauben	3x30	2	
4	Holzschrauben	3x25	14	
5	Holzschrauben	3x35	62	
6	Holzschrauben	4x16	6	
7	Turscharnier	L150mm	2	
8	Turriegel	100x4	1	
A	Modul-Rückwand	575x1785	3	
B	Seitenelemente	1150x1785	2	
C	Vorwand links	490x1785	1	
D	Vorwand rechts	490x1785	1	
E	Tur	735x1760	1	
F	Kantholz von Seitenelemente	30x50x1150	2	
G	Giebelelement	305x1725	2	
H	Eckleisten	12x410x1805	4	
I	Dachhalfen	1030x1380	2	
J	Dachrandleisten	14x50x1380	2	
K	Giebelblende	16x95x1080	4	
L	Deckleisten	12x41x1775	2	
M	Boden	1190x1725	1	

Gerätehaus Berlin-1

Kanthalolz 3,5x3,0

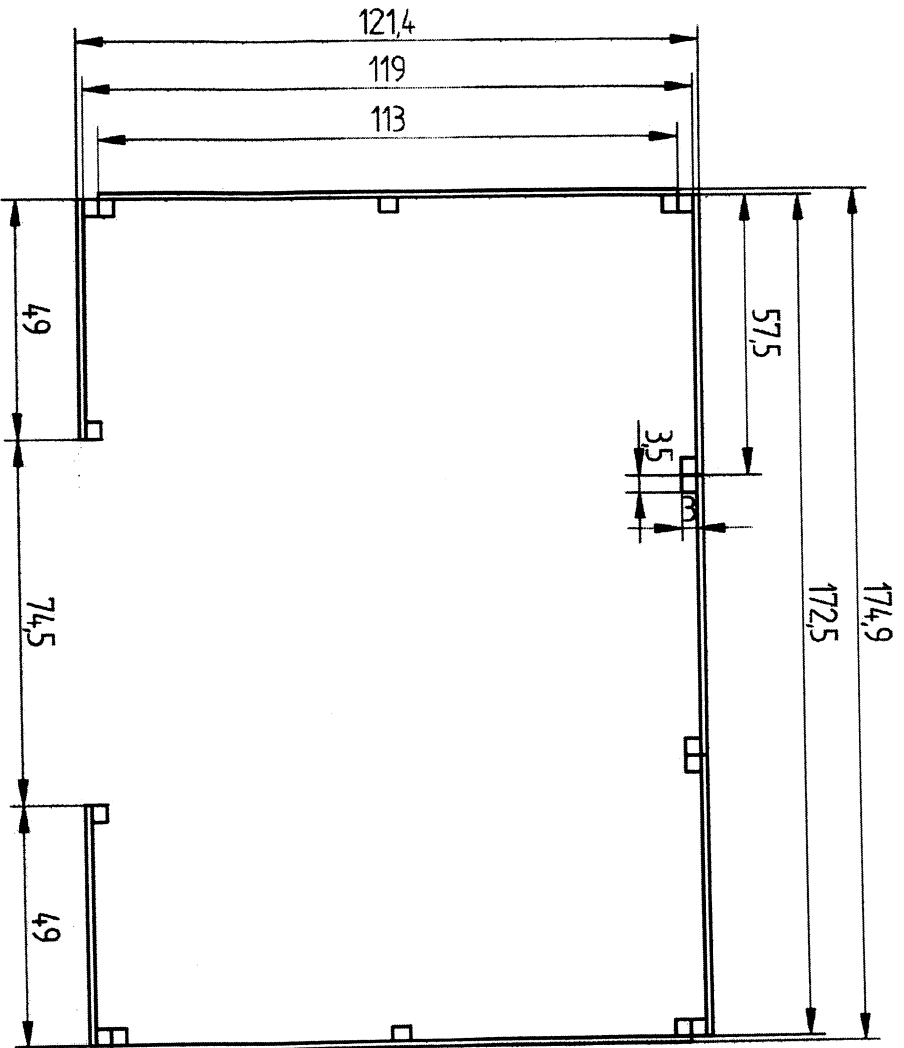

SKALA 1:15

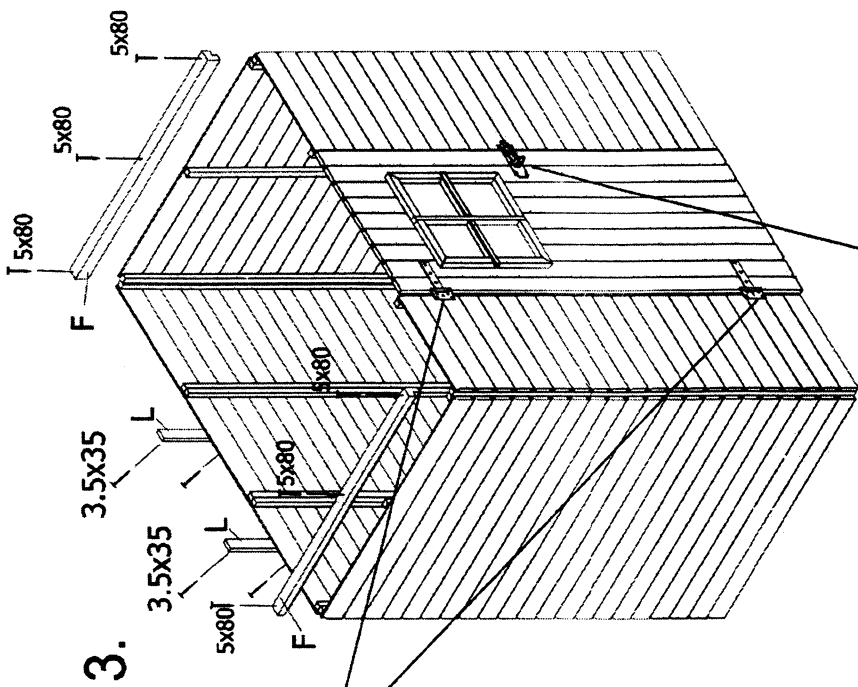
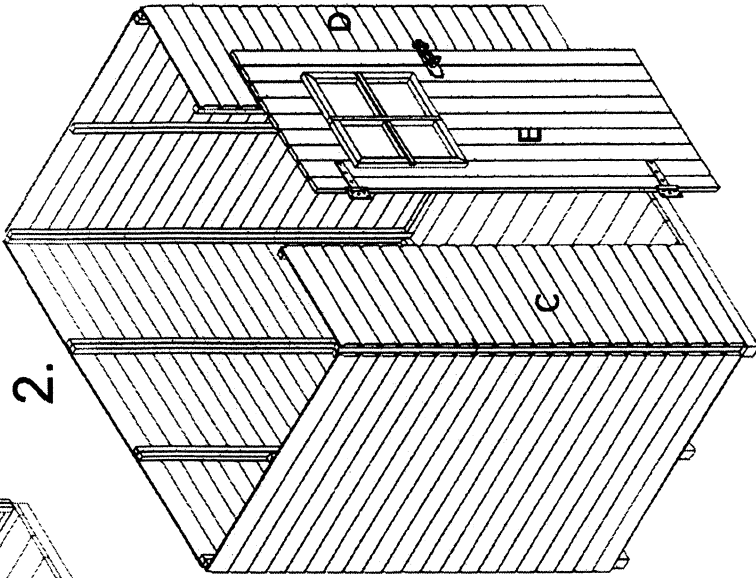
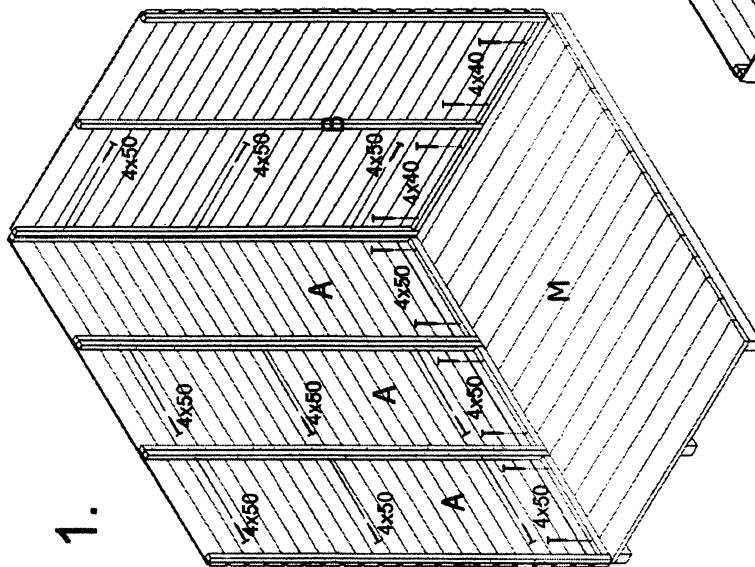

4.

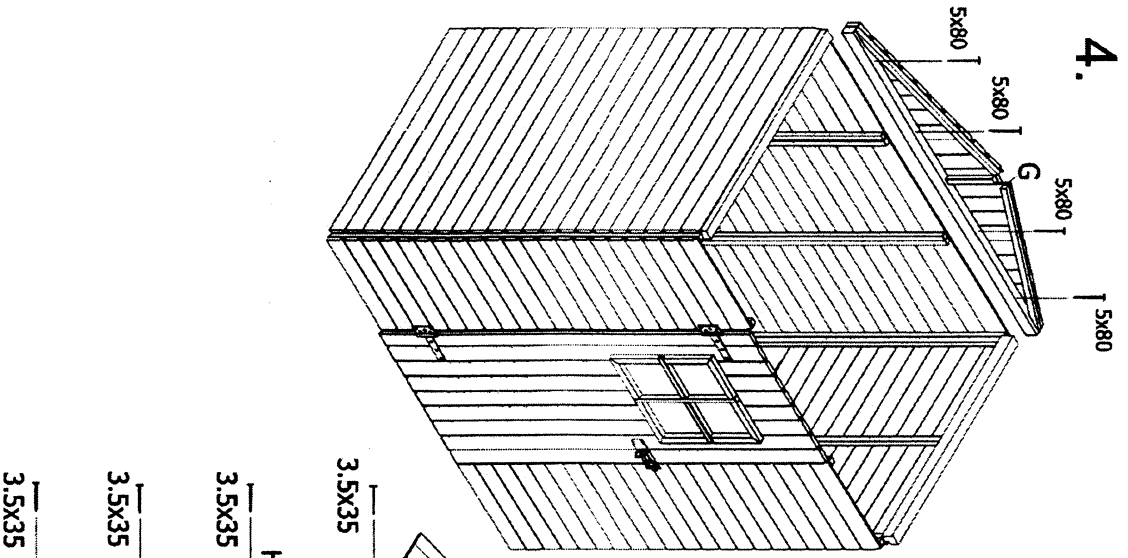

5.

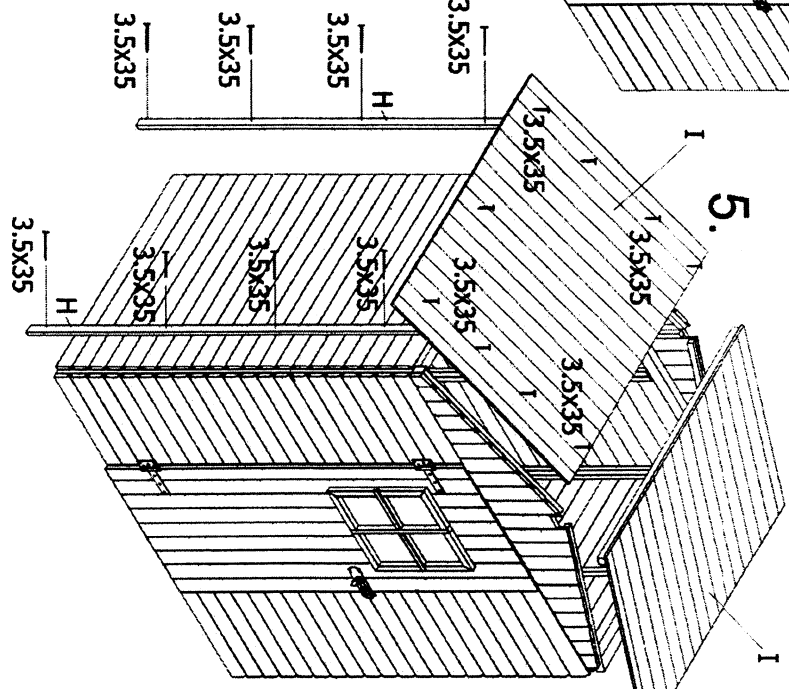

6.

